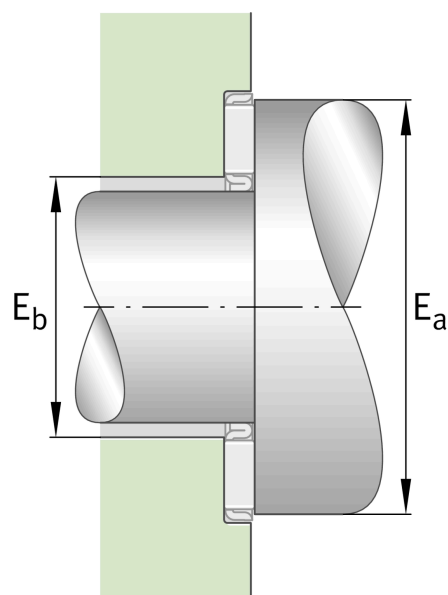
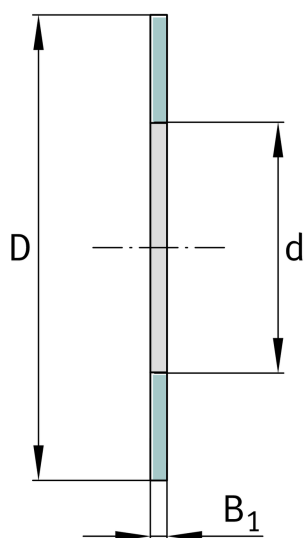
**AS1024**

Axial bearing washer

Schaeffler ID:  
0000297500000Axial bearing washers, suitable for AXK  
and K811, to DIN 5405-3/ISO 303

## Technical information

**Main Dimensions & Performance Data**

d	10 mm	Bore diameter bearing washer
D	24 mm	Outside diameter bearing washer
B <sub>1</sub>	1 mm	Height bearing washer
	2.7 g	Weight